

800 - 3000MHz High IP3 Dual LNA

TGA2602-SM



Key Features and Performance

- 800 - 3000 MHz Frequency Range
- <0.6 dB Noise Figure
- 22dB Gain
- Bias Conditions: 4V/100mA
- Package Dimensions: 2.0 x 2.0 x 0.9 mm

Primary Applications

- Wireless Basestation
- WiMAX

Measured Data

Balanced Amplifier Data

Vd=4V Id=100mA

Product Description

The TriQuint TGA2602-SM is a packaged low noise amplifier. The TGA2602-SM operates from 800 - 3000 MHz.

The TGA2602-SM typically provides <0.6dB noise figure with a small signal gain of >19 dB at 1950MHz.

The TGA2602-SM is available in a low-cost, surface mount 6 lead 2x2 QFN style package and is ideally suited for wireless basestation and WiMAX applications.

Balanced Evaluation Boards are available upon request.

Lead-free and RoHS compliant.

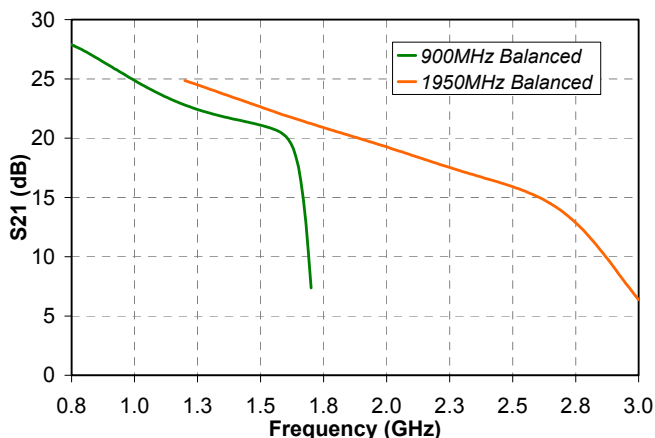
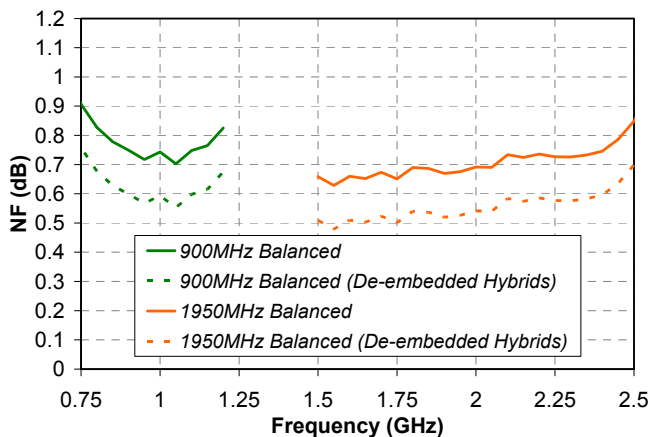

Note: This device is early in the characterization process prior to finalizing all electrical test specifications. Specifications are subject to change without notice.

**TABLE I
MAXIMUM RATINGS**

Symbol	Parameter	Value	Notes
V ⁺	Positive Supply Voltage	5 V	<u>1/</u> <u>2/</u>
V ⁻	Negative Supply Voltage	-1V to 0.5V	<u>1/</u>
I ⁺	Positive Supply Current (per channel)	100 mA	<u>1/</u> <u>2/</u>
I ⁻	Negative Supply Current (per channel)	5 mA	<u>1/</u>
P _{IN}	Input Continuous Wave Power	TBD	<u>1/</u> <u>2/</u>
P _D	Power Dissipation	TBD	<u>1/</u> <u>2/</u> <u>3/</u>
T _{CH}	Operating Channel Temperature	150 °C	<u>4/</u>
T _M	Mounting Temperature (10 Seconds)	260 °C	
T _{STG}	Storage Temperature	-65 to 150 °C	

- 1/ These ratings represent the maximum operable values for this device
- 2/ Combinations of supply voltage, supply current, input power, and output power shall not exceed P_D at a package base temperature of 80°C
- 3/ When operated at this bias condition with a baseplate temperature of 80°C, the MTTF is reduced
- 4/ Junction operating temperature will directly affect the device median time to failure (MTTF). For maximum life, it is recommended that junction temperatures be maintained at the lowest possible levels.

**TABLE II
THERMAL INFORMATION**

Parameter	Test Conditions	T _{CH} (°C)	R _{θJC} (°C/W)	MTTF (hrs)
R _{θJC} Thermal Resistance (Channel to Backside of Package)	V _D = 3.5V I _D = 100mA P _{DISS} = 0.35W T _{BASE} = 70°C	97	48.6	1E+6

Note: Thermal transfer is conducted through the bottom of the TGA2602-SM package into the motherboard.

**TABLE IIIA – 900MHz Balanced Amplifier
RF CHARACTERIZATION TABLE
(T_A = 25°C, Nominal)
V_d=4V, I_d=100mA**

Parameter	Test Conditions	Typ	Units	Notes
Small Signal Gain	850 – 900 MHz	26	dB	
Input Return Loss	850 – 900 MHz	27	dB	
Output Return Loss	850 – 900 MHz	25	dB	
Noise Figure	850 – 900 MHz	0.75	dB	
Input Third Order Intercept	850 – 900 MHz	5	dBm	

**TABLE IIIB – 1950MHz Balanced Amplifier
RF CHARACTERIZATION TABLE
(T_A = 25°C, Nominal)
V_d=4V, I_d=100mA**

Parameter	Test Conditions	Typ	Units	Notes
Small Signal Gain	1950 MHz	19.5	dB	
Input Return Loss	1950 MHz	16	dB	
Output Return Loss	1950 MHz	25	dB	
Noise Figure	1950 MHz	0.65	dB	
Input Third Order Intercept	1950 MHz	13.5	dBm	

Single Channel 1950MHz Application Circuit

4V 50mA (Refer to Page 17)

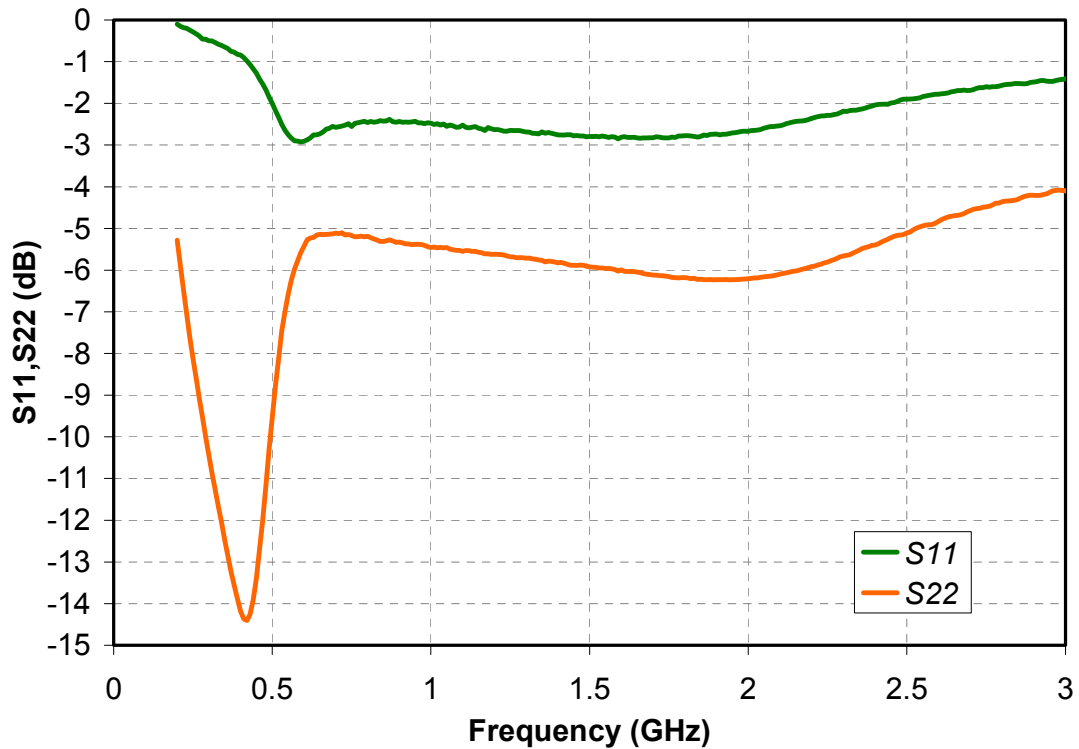
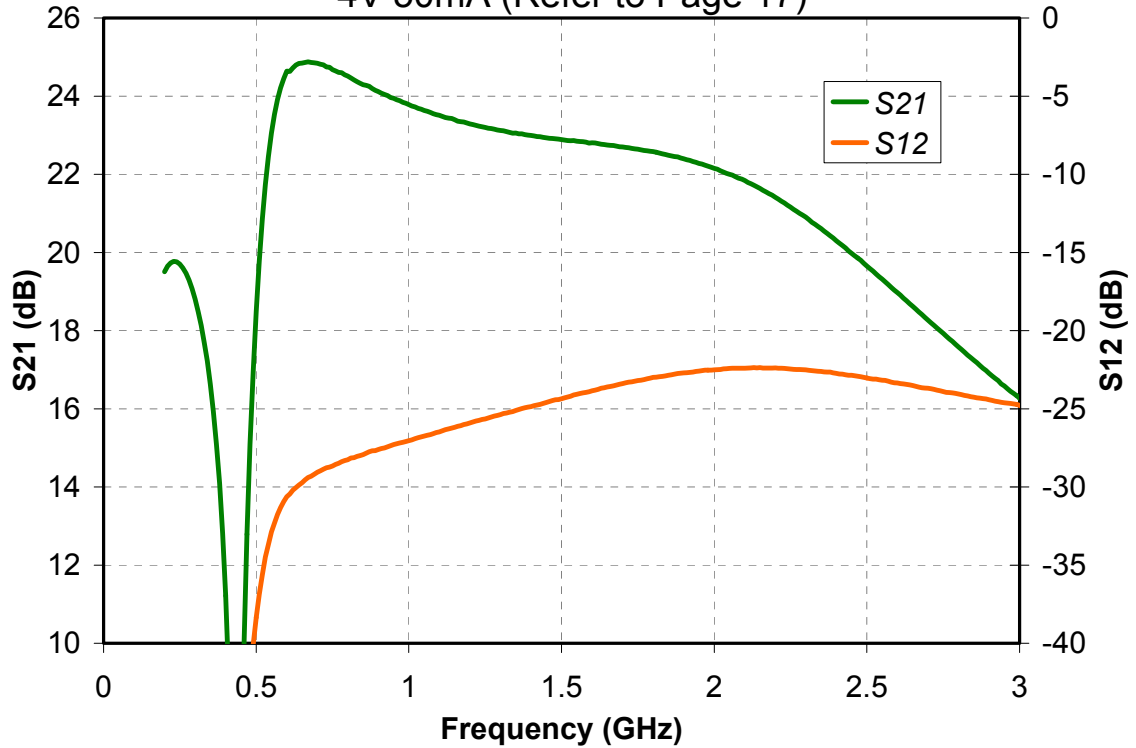

Single Channel 1950MHz Application Circuit

4V 50mA (Refer to Page 17)

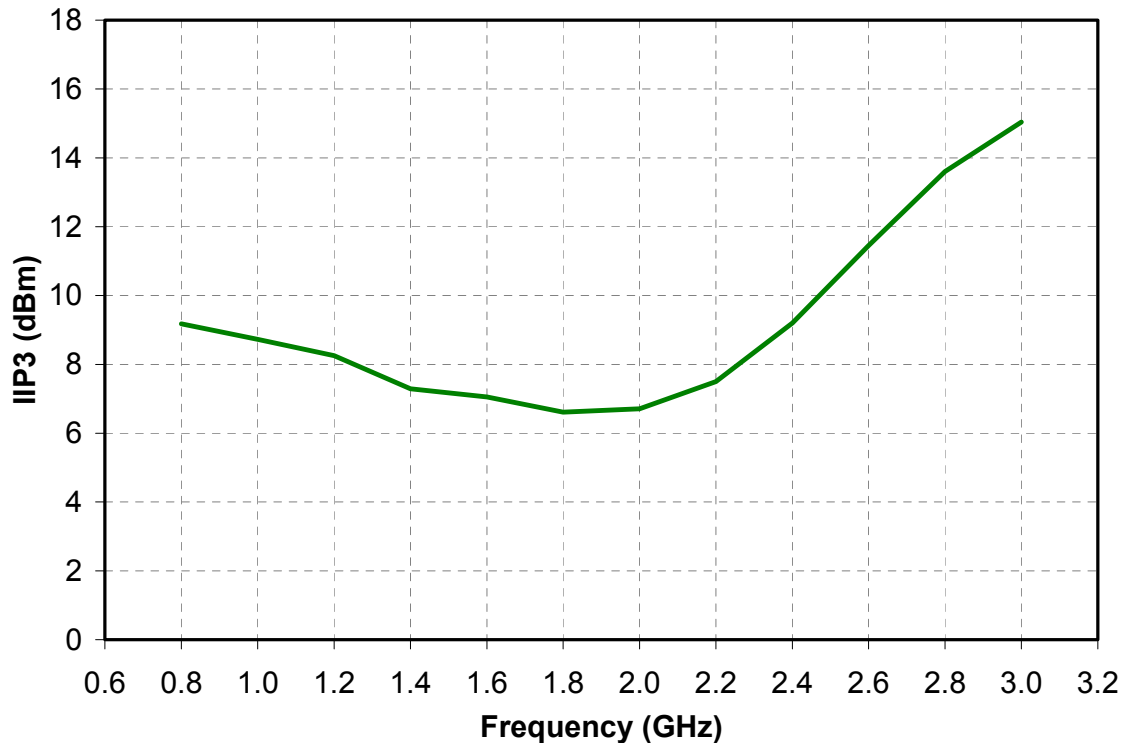
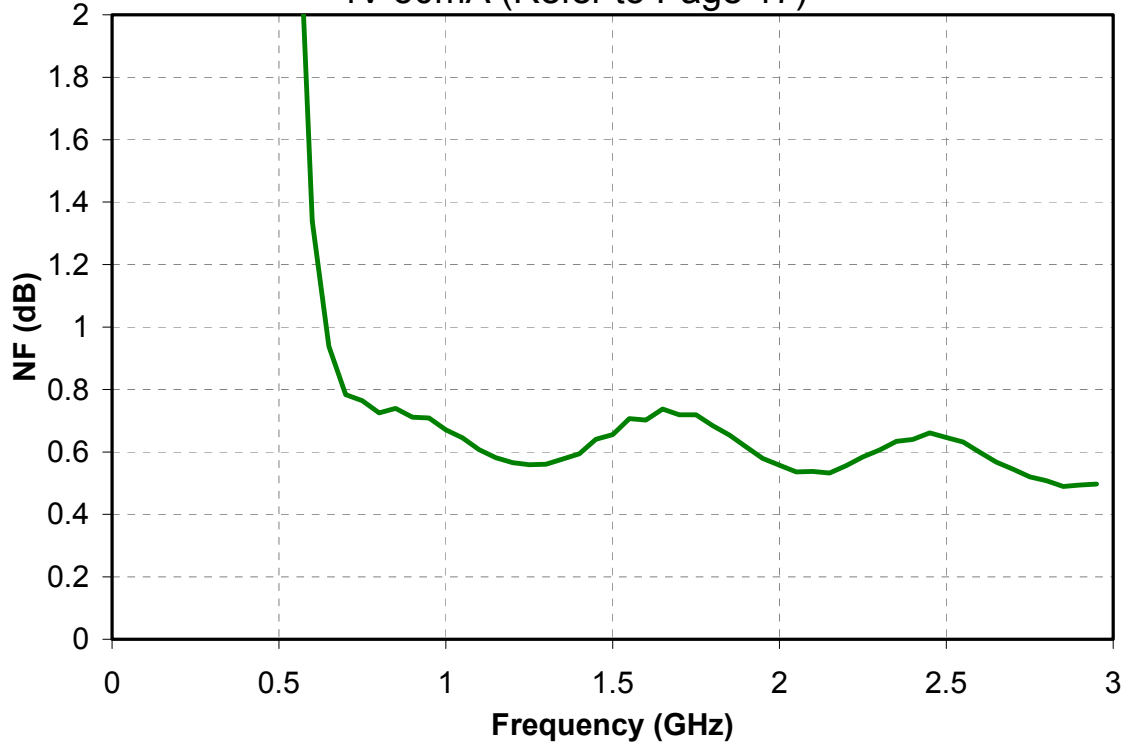

Single Channel 1950MHz Application Circuit

4V 50mA (Refer to Page 17)

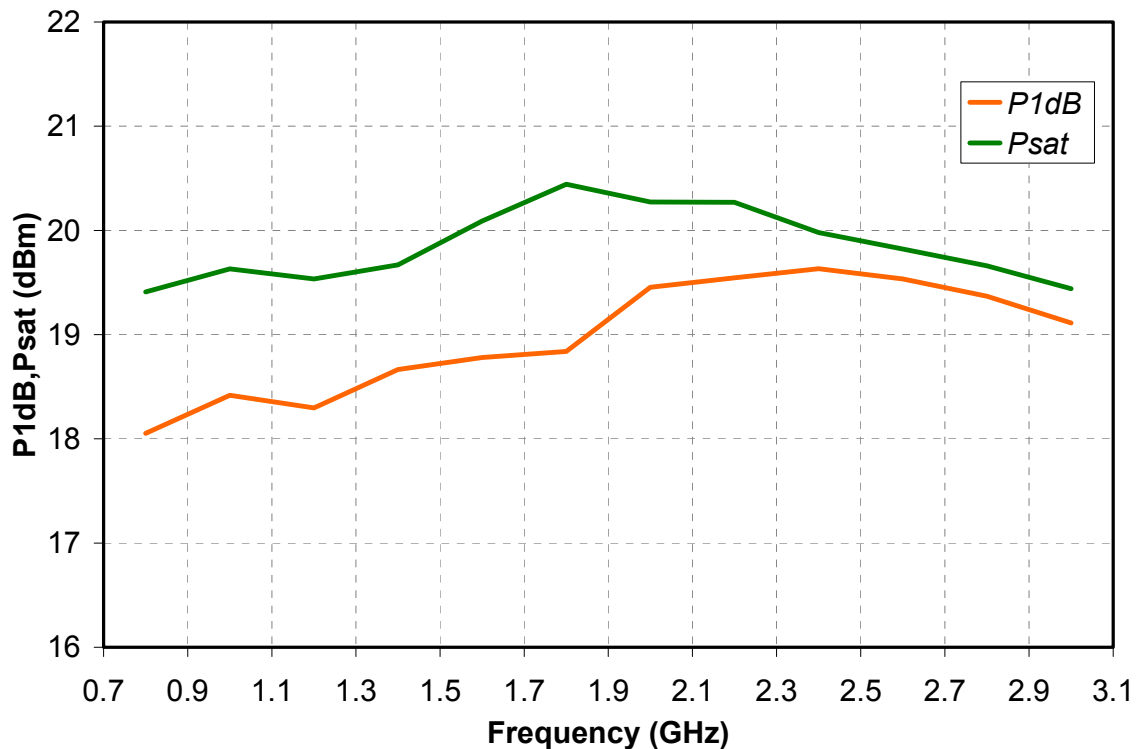
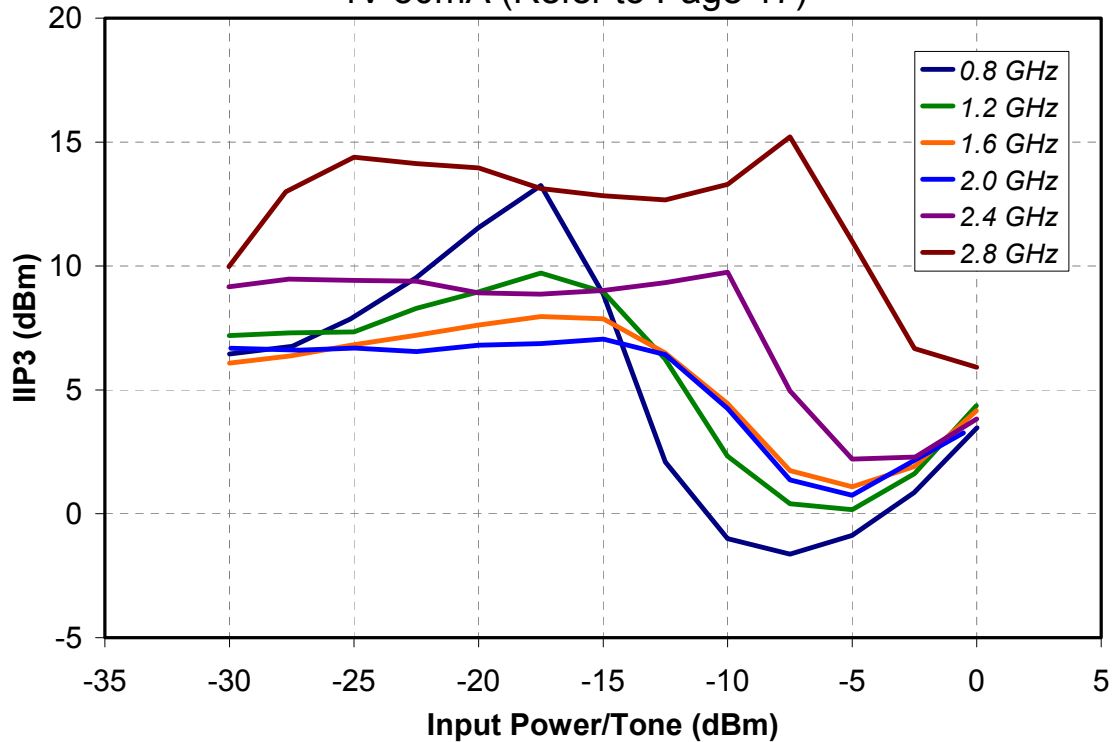

900MHz Balanced Amplifier Circuit

4V 100mA (Refer to Page 19)

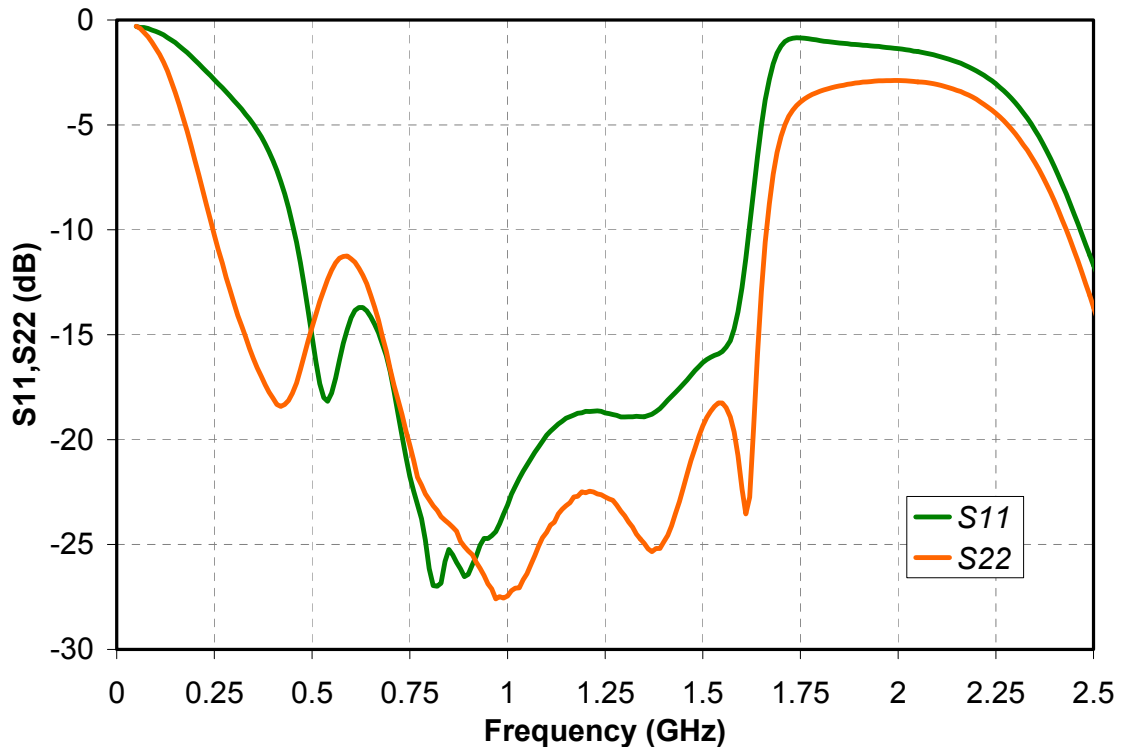
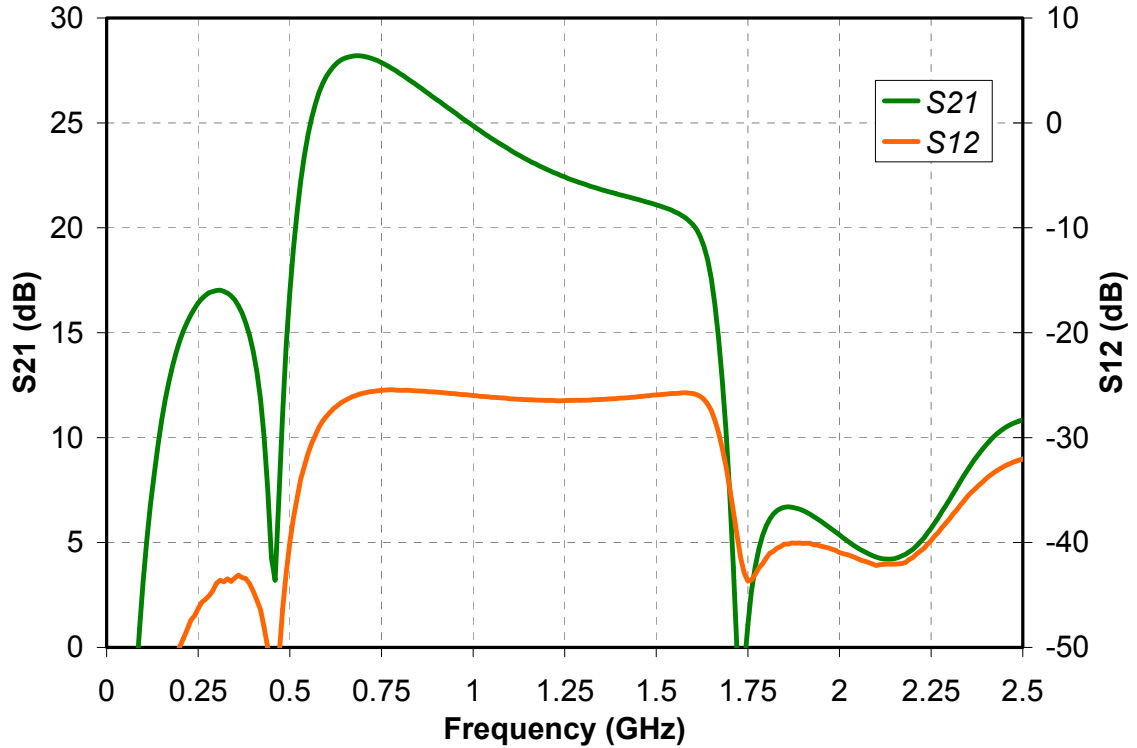

900MHz Balanced Amplifier Circuit

4V 100mA (Refer to Page 19)

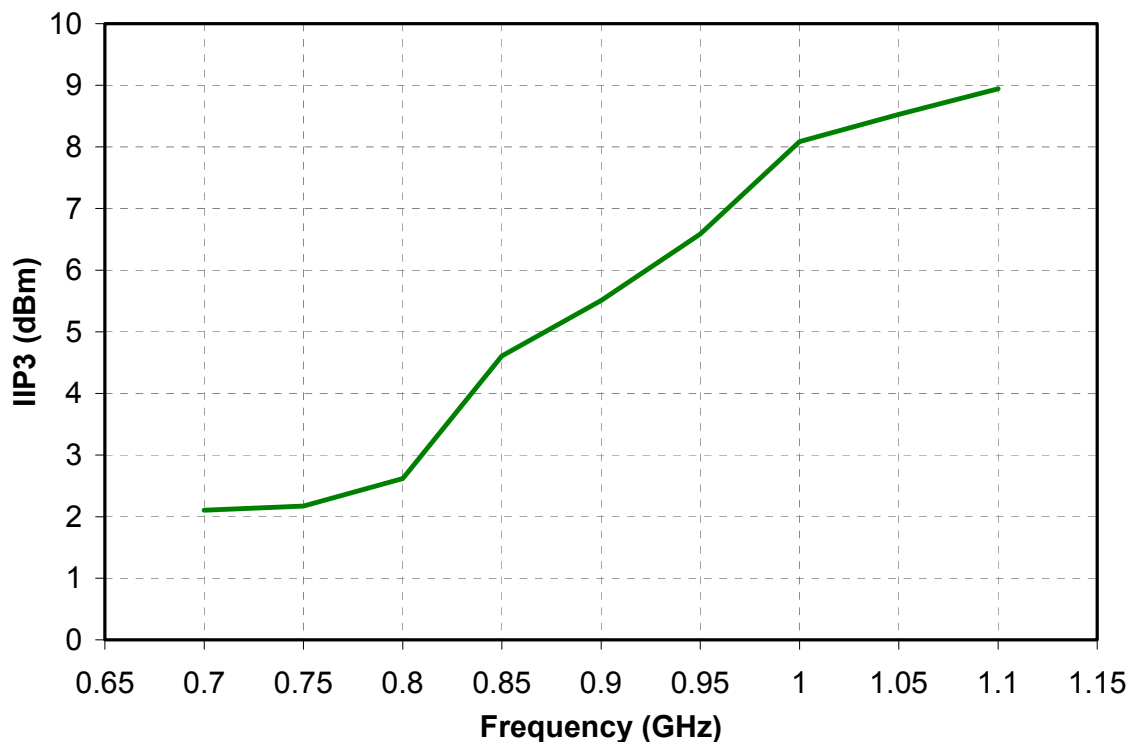
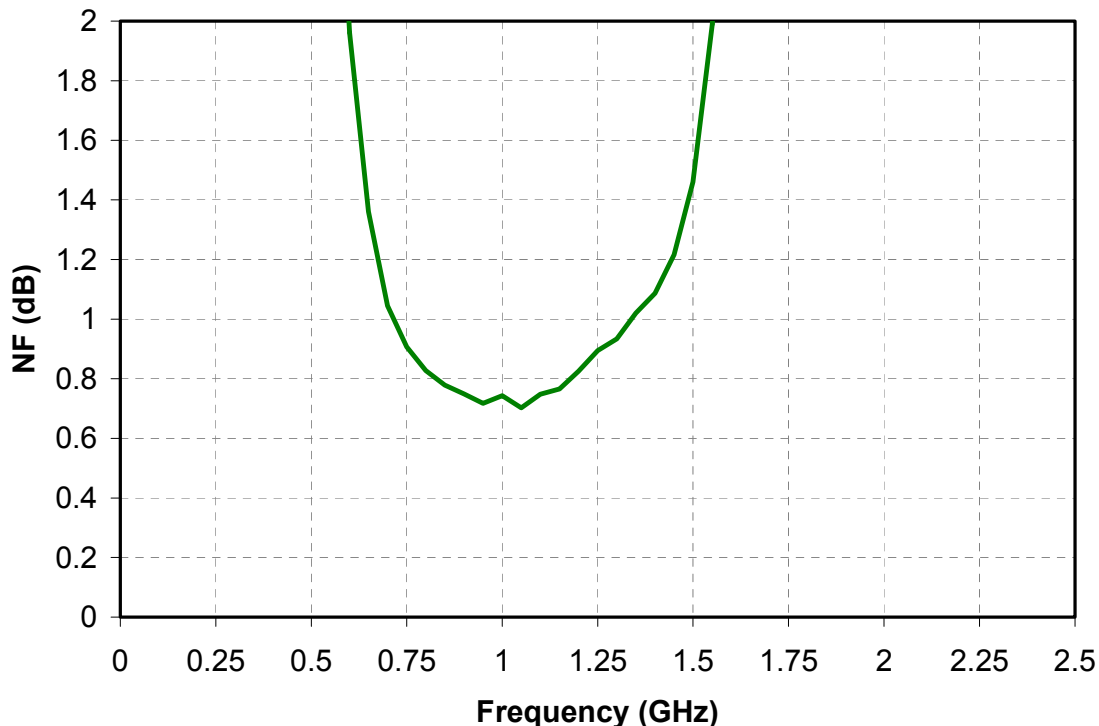

900MHz Balanced Amplifier Circuit

4V 100mA (Refer to Page 19)

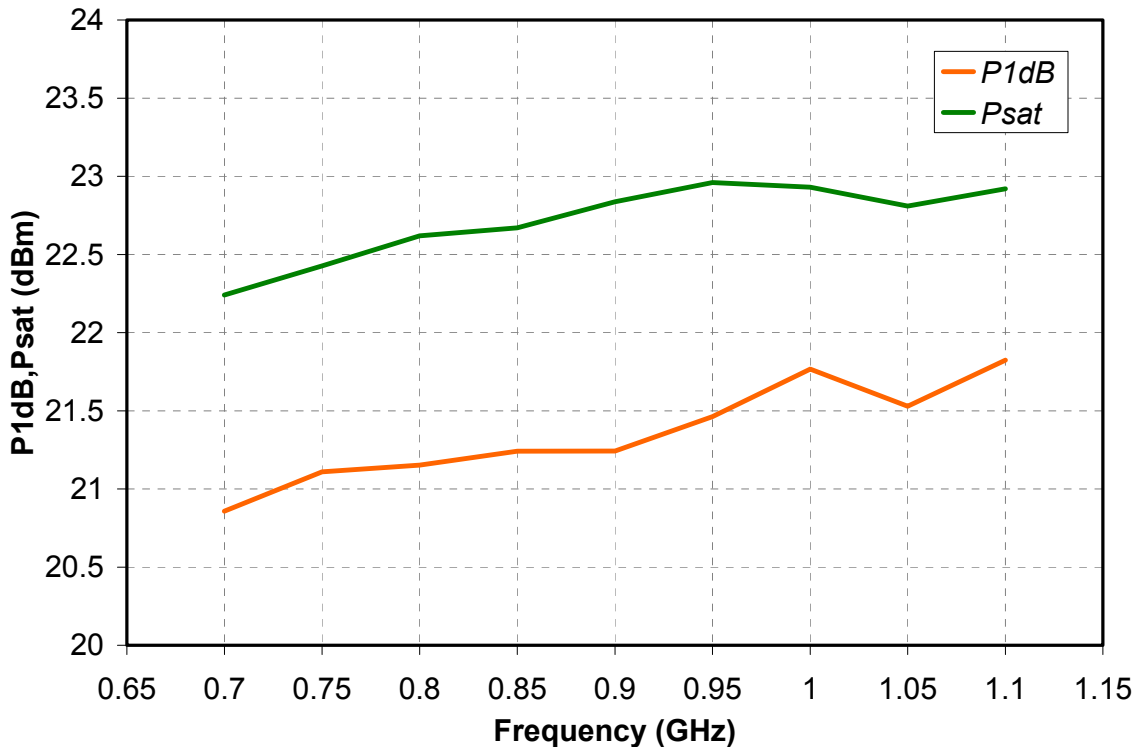
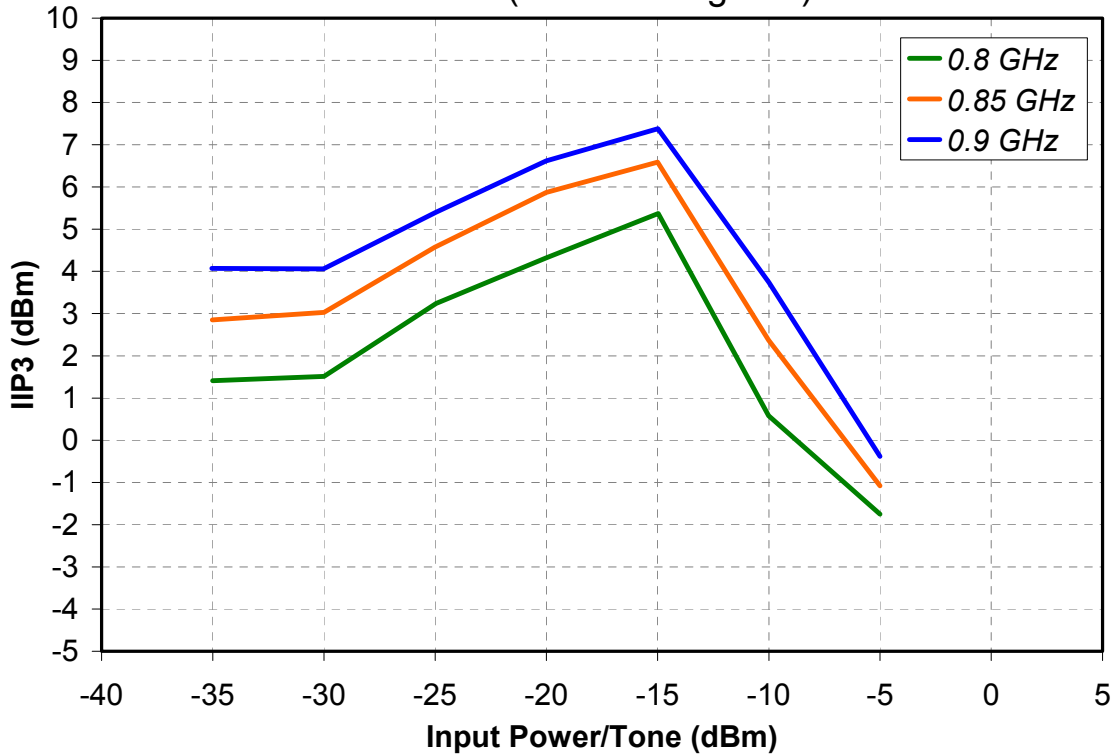

1950MHz Balanced Amplifier Circuit

4V 100mA (Refer to Page 20)

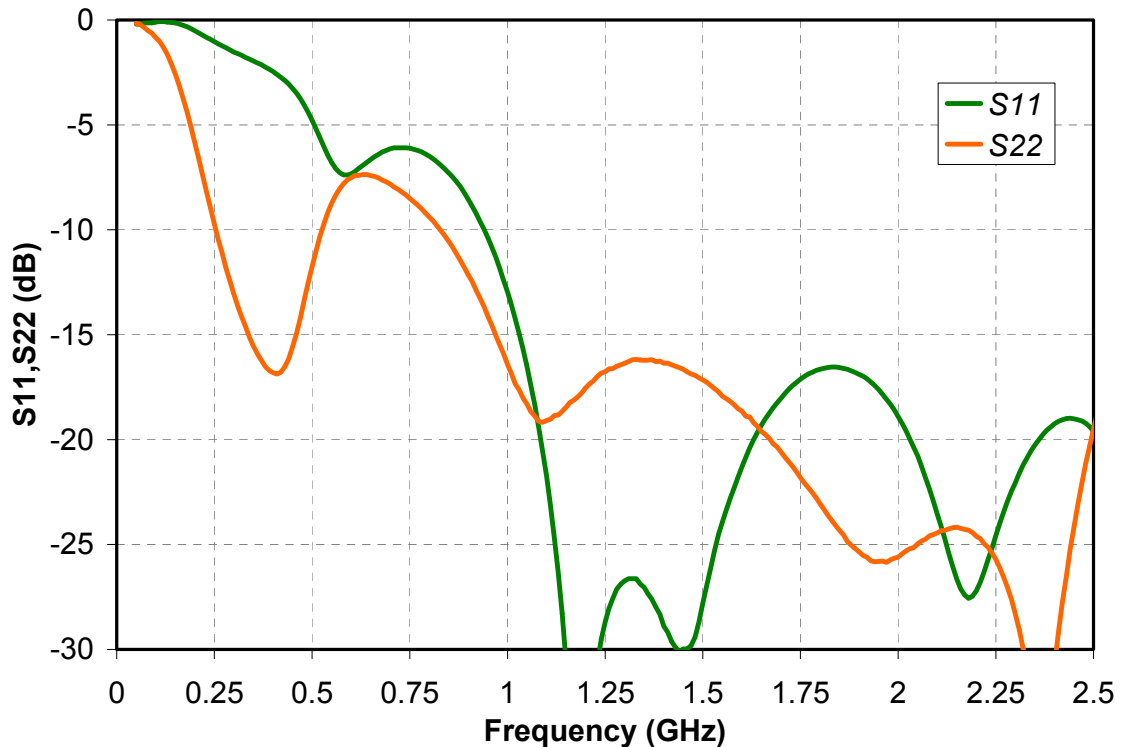
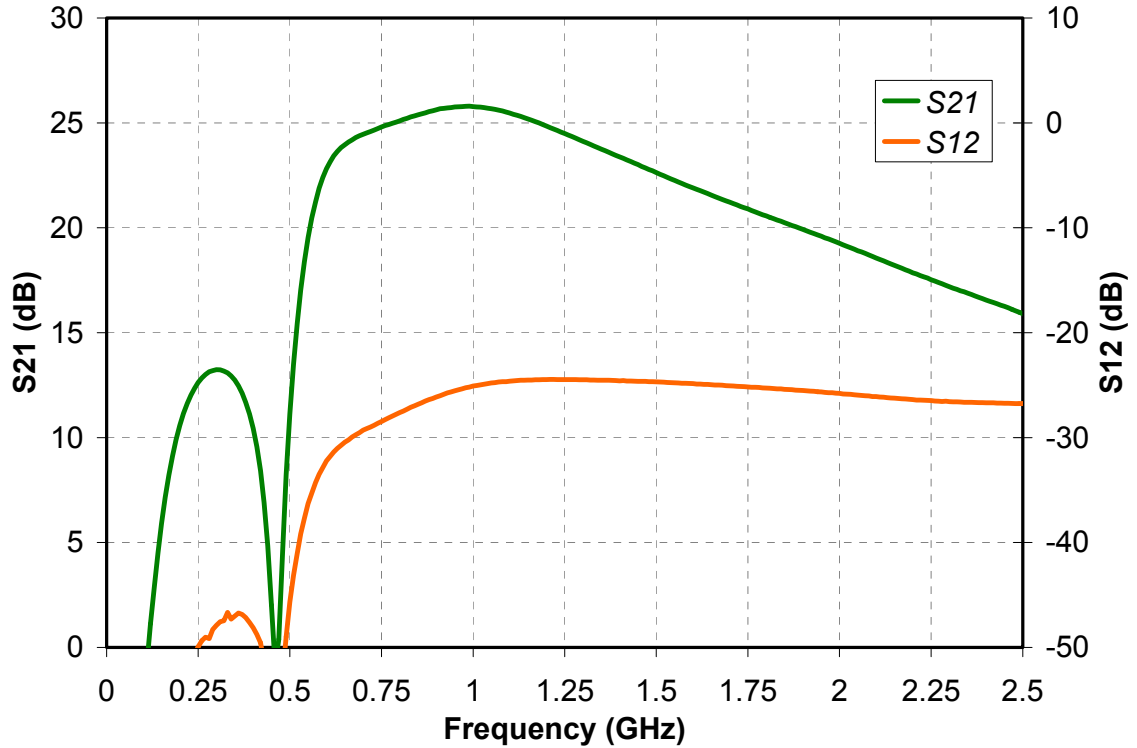

1950MHz Balanced Amplifier Circuit

4V 100mA (Refer to Page 20)

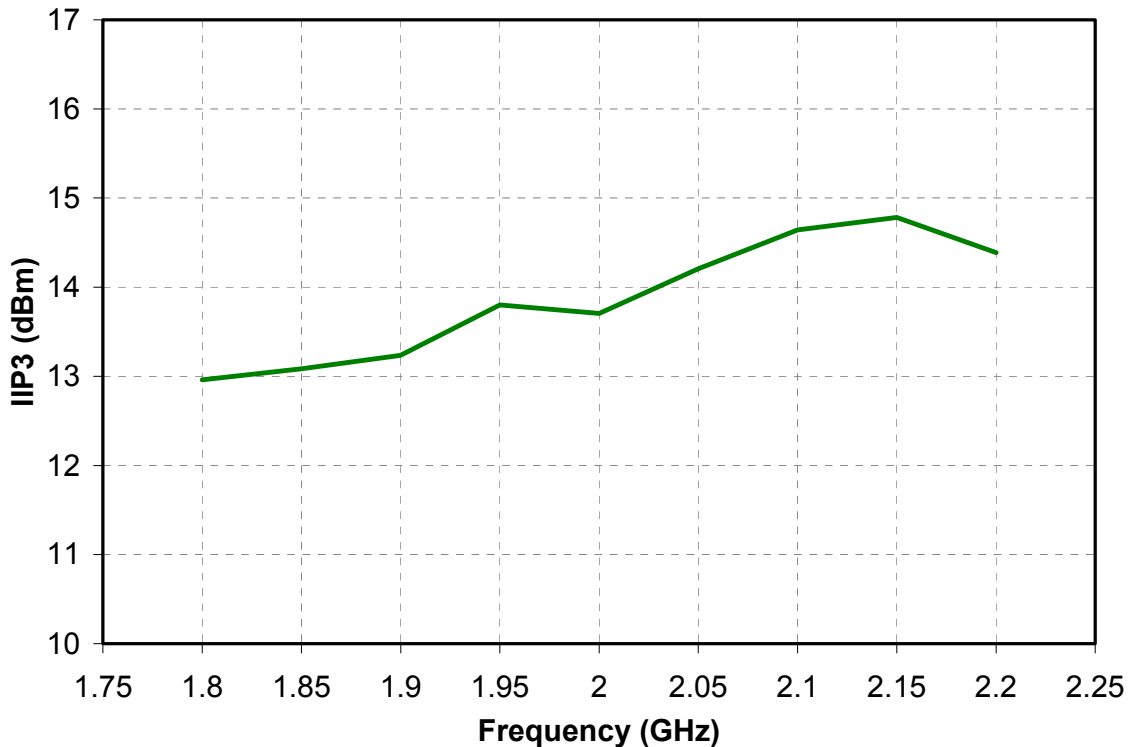
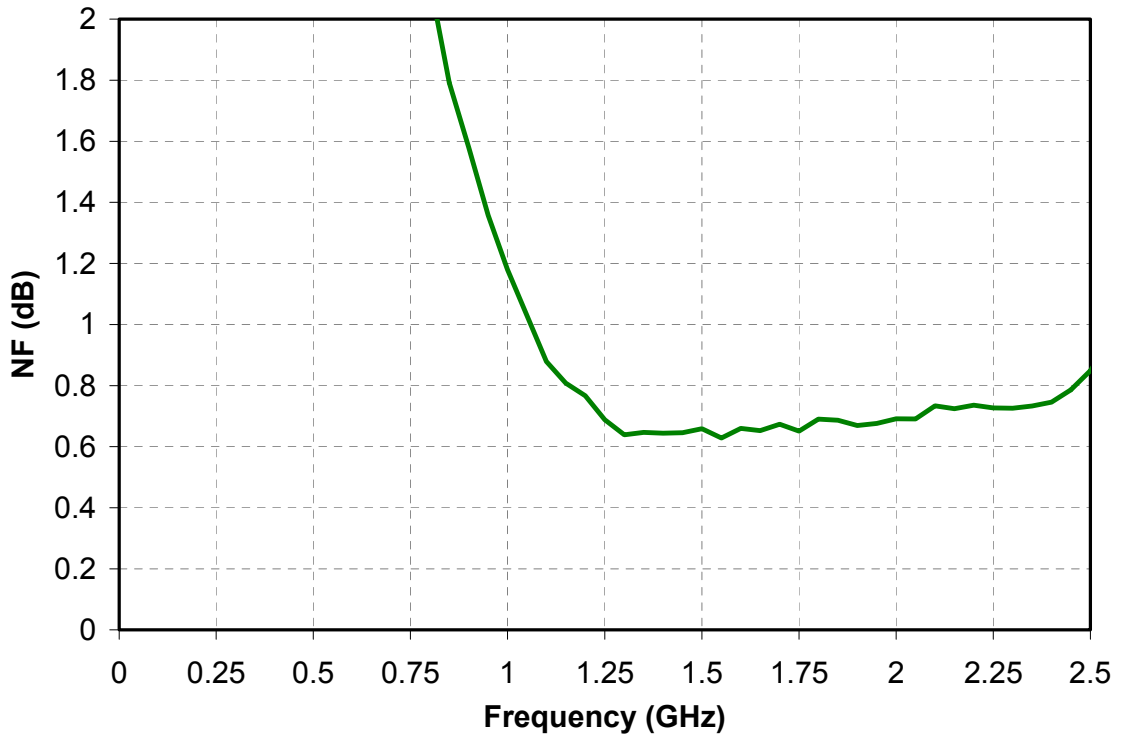

1950MHz Balanced Amplifier Circuit

4V 100mA (Refer to Page 20)

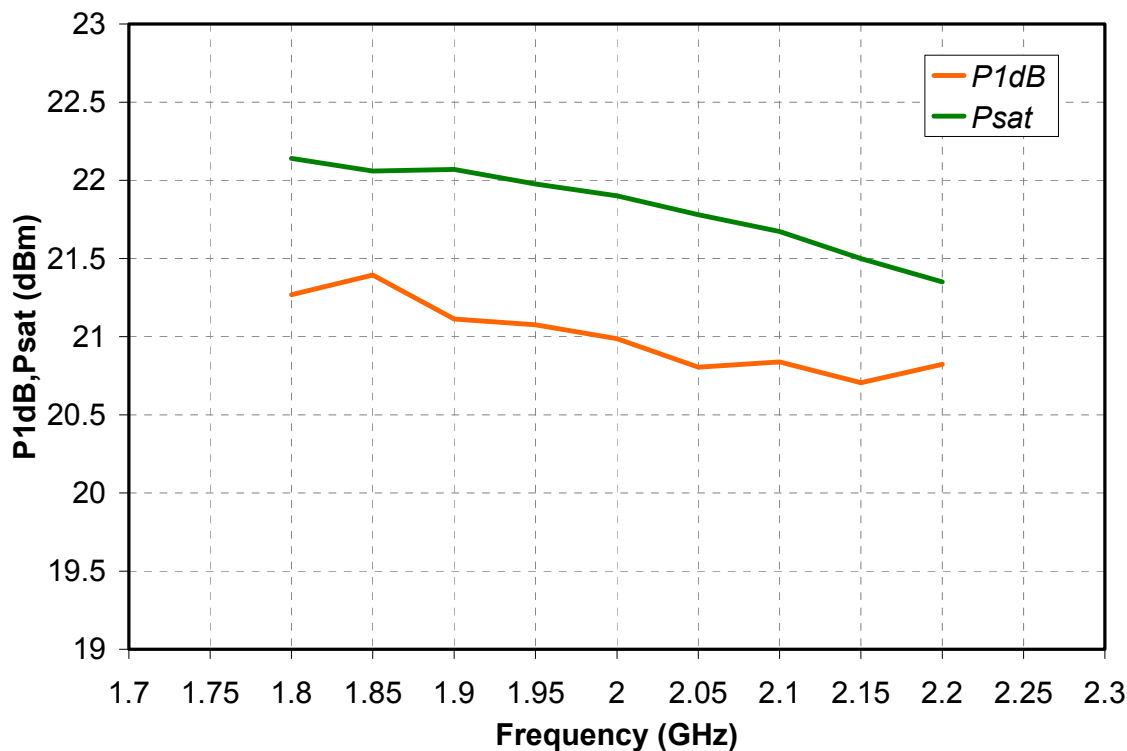
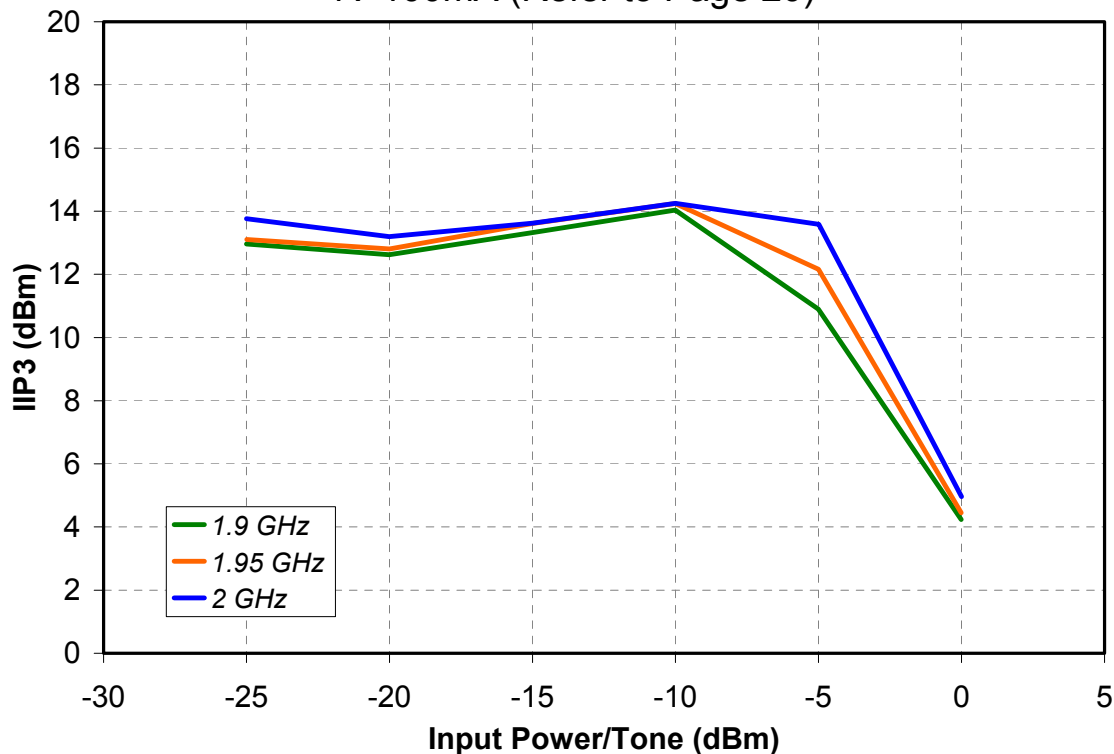

Package S-Parameters

4V 50mA

Freq	S11mag	S11ang	S21Mag	S21Ang	S12Mag	S12Ang	S22Mag	S22Ang
0.5	0.954	-37.26	16.273	152.65	0.024	67.71	0.315	-42.03
1	0.873	-75.01	14.862	126.55	0.045	46.61	0.32	-83.94
1.5	0.812	-108.98	12.833	104.16	0.059	29.33	0.325	-118.8
2	0.764	-140.5	10.831	84.13	0.067	14.77	0.315	-148.91
2.5	0.72	-166.36	8.942	67.36	0.07	3.91	0.296	-174.63
3	0.728	172.09	7.598	52.21	0.072	-8.36	0.296	159.51
3.5	0.739	154.15	6.516	38.58	0.075	-17.56	0.309	139.75
4	0.748	139.42	5.792	25.59	0.08	-24.69	0.346	128.19
4.5	0.731	125.28	5.438	12.76	0.08	-35.53	0.368	115.45
5	0.704	107.03	4.934	-1.21	0.084	-47.45	0.414	101.4
5.5	0.633	88.38	4.256	-18.11	0.079	-60.93	0.508	92
6	0.52	70.65	3.445	-33.7	0.066	-79.86	0.589	80.89
6.5	0.437	49.7	2.817	-44.76	0.058	-76.88	0.615	66.94
7	0.343	25.91	2.198	-54.88	0.047	-82.13	0.632	56.78
7.5	0.371	16.85	1.928	-59.39	0.057	-70.57	0.616	47.97
8	0.36	4.5	1.634	-64.52	0.059	-82.19	0.638	42.59
8.5	0.55	10.56	1.669	-69.29	0.048	-82.8	0.659	35.1
9	0.632	0.45	1.505	-78.54	0.07	-90.11	0.649	28.92
9.5	0.716	-5.53	1.328	-86.54	0.078	-107.09	0.666	20.26
10	0.751	-8.7	1.21	-88.2	0.077	-124.58	0.627	12.76
10.5	0.815	-11.2	1.174	-95.35	0.058	-146.77	0.648	6.67
11	0.869	-15.32	1.103	-104.6	0.049	-137.66	0.657	0.35
11.5	0.709	-13.72	1.127	-98.86	0.056	-134.9	0.673	-5.53
12	0.867	-11.72	1.188	-118.37	0.057	-144.64	0.692	-13.25

Package Pinout Diagram

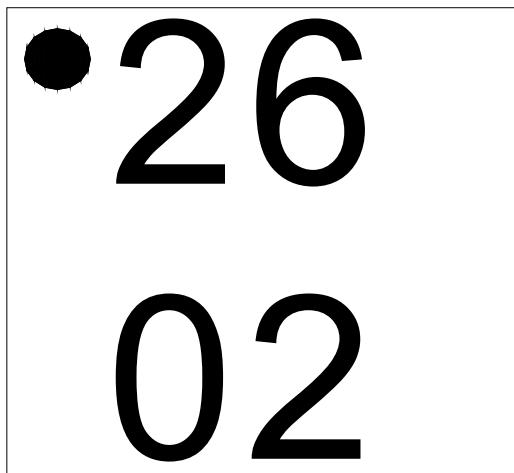

Top View

Dot indicates Pin 1

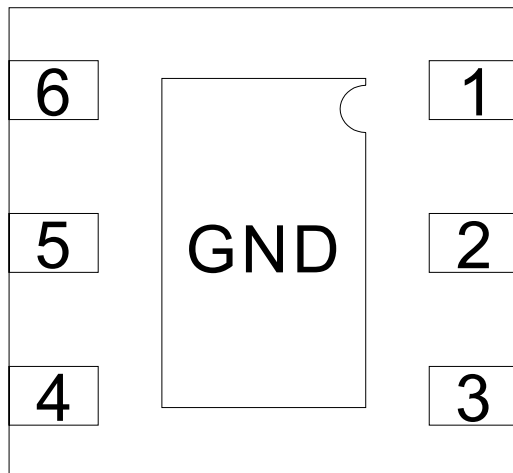

Bottom View

Pin	Description
1	RF In A / VgA
2,5	N/C
3	RF In B / VgB
4	RF Out B / VdB
6	RF Out A / VdA

GaAs MMIC devices are susceptible to damage from Electrostatic Discharge. Proper precautions should be observed during handling, assembly and test.

Mechanical Drawing

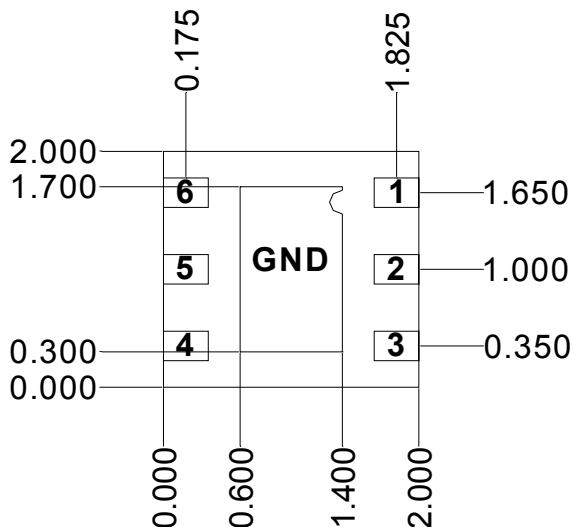

Package dimensions are in mm. Unless otherwise specified, package tolerances are ± 0.050 mm.

Package Pad #1	RF In A / VgA	0.350 x 0.250
Package Pad #2	N/C	0.350 x 0.250
Package Pad #3	RF In B / VgB	0.350 x 0.250
Package Pad #4	RF Out B / VdB	0.350 x 0.250
Package Pad #5	N/C	0.350 x 0.250
Package Pad #6	RF Out A / VdA	0.350 x 0.250

Single Channel 1950MHz Application Schematic

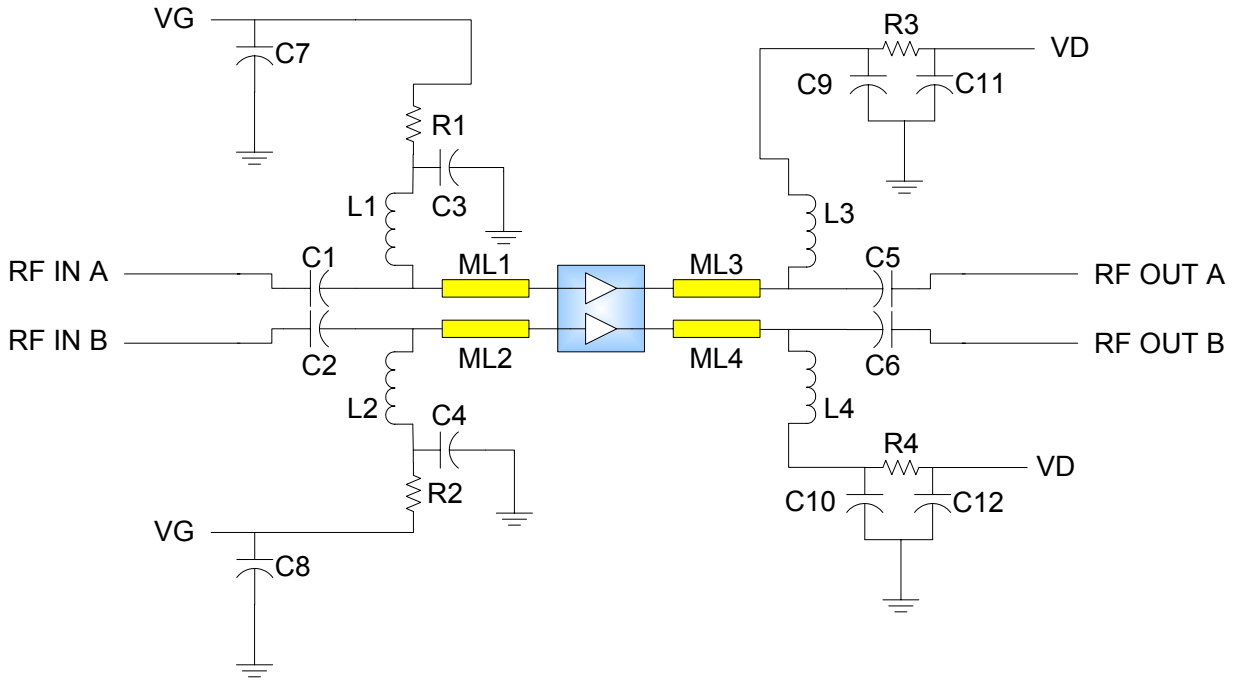

Designator	Component
C1,C2	22pF Capacitor
C3,C4	4.7pF Capacitor
C5,C6,C9,C10	10pF Capacitor
C7,C8,C11,C12	1uF Capacitor
L1,L2	22nH Inductor
L3,L4	47nH Inductor
R1,R2	2.2kOhm Resistor
R3,R4	10Ohm Resistor

Designator	Impedance	Electrical Length @ 2GHz
ML1,ML2	117 Ohm	14 degrees
ML3,ML4	82 Ohm	3 degrees

Single Channel 1950MHz Application Layout

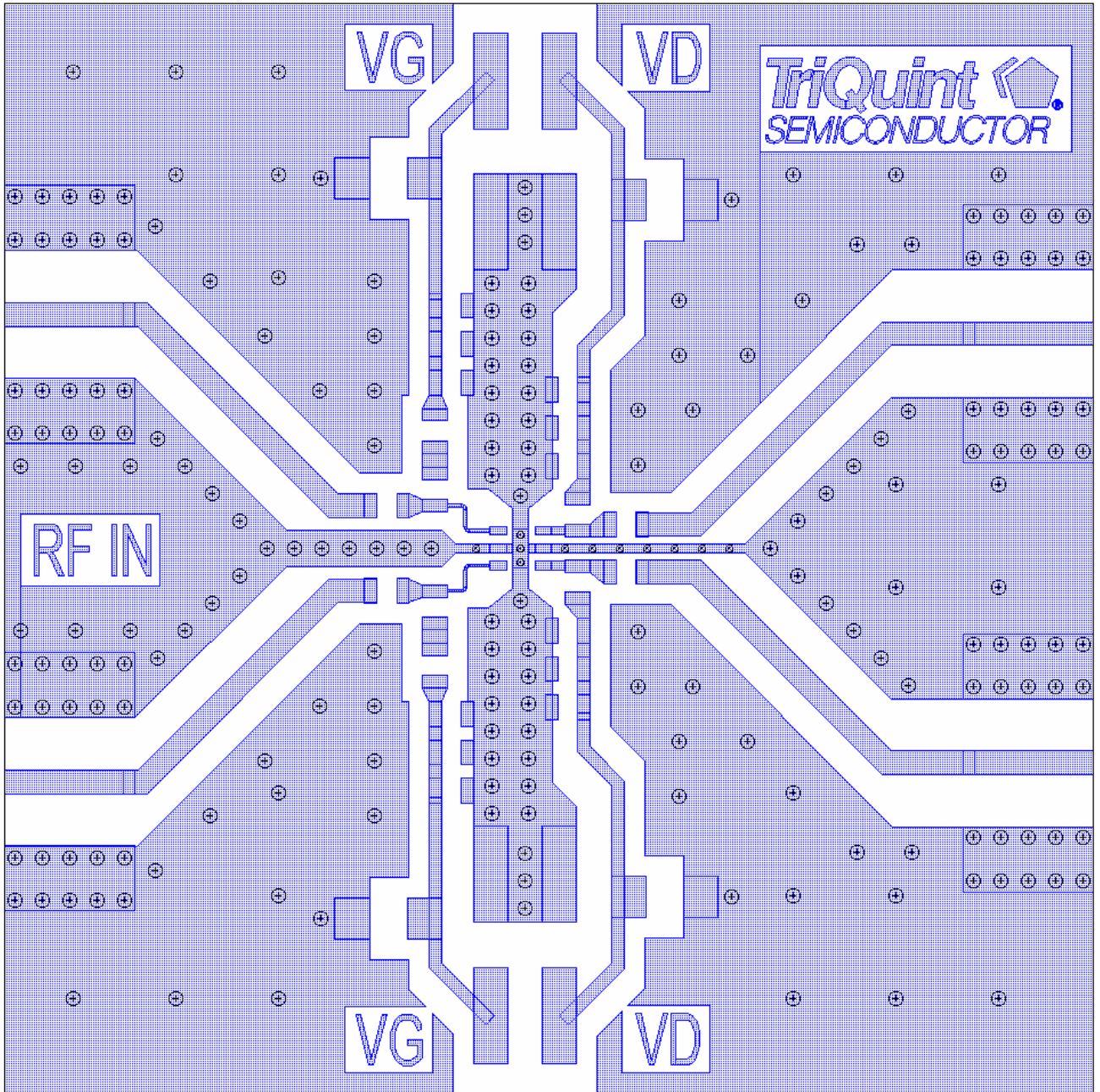

Balanced Amplifier Circuit Schematic

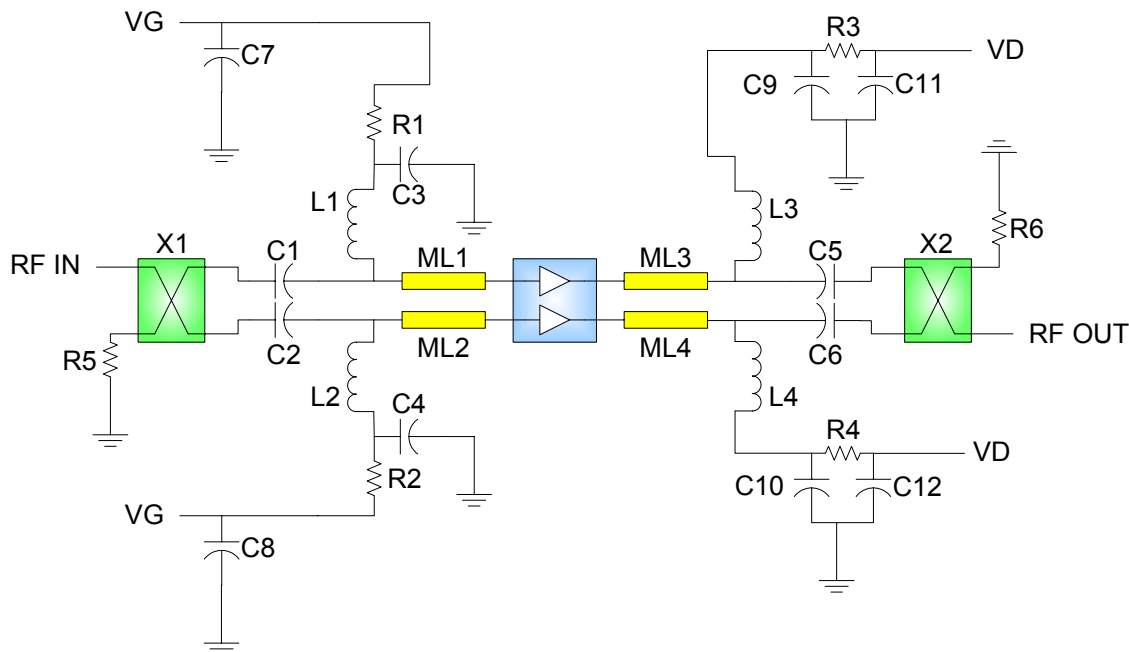

Designator	Component
C1,C2	22pF Capacitor
C3,C4	4.7pF Capacitor
C5,C6,C9,C10	10pF Capacitor
C7,C8,C11,C12	1uF Capacitor
L1,L2	22nH Inductor
L3,L4	47nH Inductor
R1,R2	2.2kOhm Resistor
R3,R4	10Ohm Resistor
R5,R6	50Ohm Resistor

900MHz Circuit

Designator	Component	Part Number
X1,X2	Anaren Hybrid	XC0900A-03

Designator	Impedance	Electrical Length @ 900MHz
ML1,ML2	96 Ohm	35 degrees
ML3,ML4	74 Ohm	8 degrees

1950MHz Circuit

Designator	Component	Part Number
X1,X2	Anaren Hybrid	XC1900A-03

Designator	Impedance	Electrical Length @ 2GHz
ML1,ML2	96 Ohm	30 degrees
ML3,ML4	74 Ohm	17 degrees

900MHz Balanced Amplifier Layout

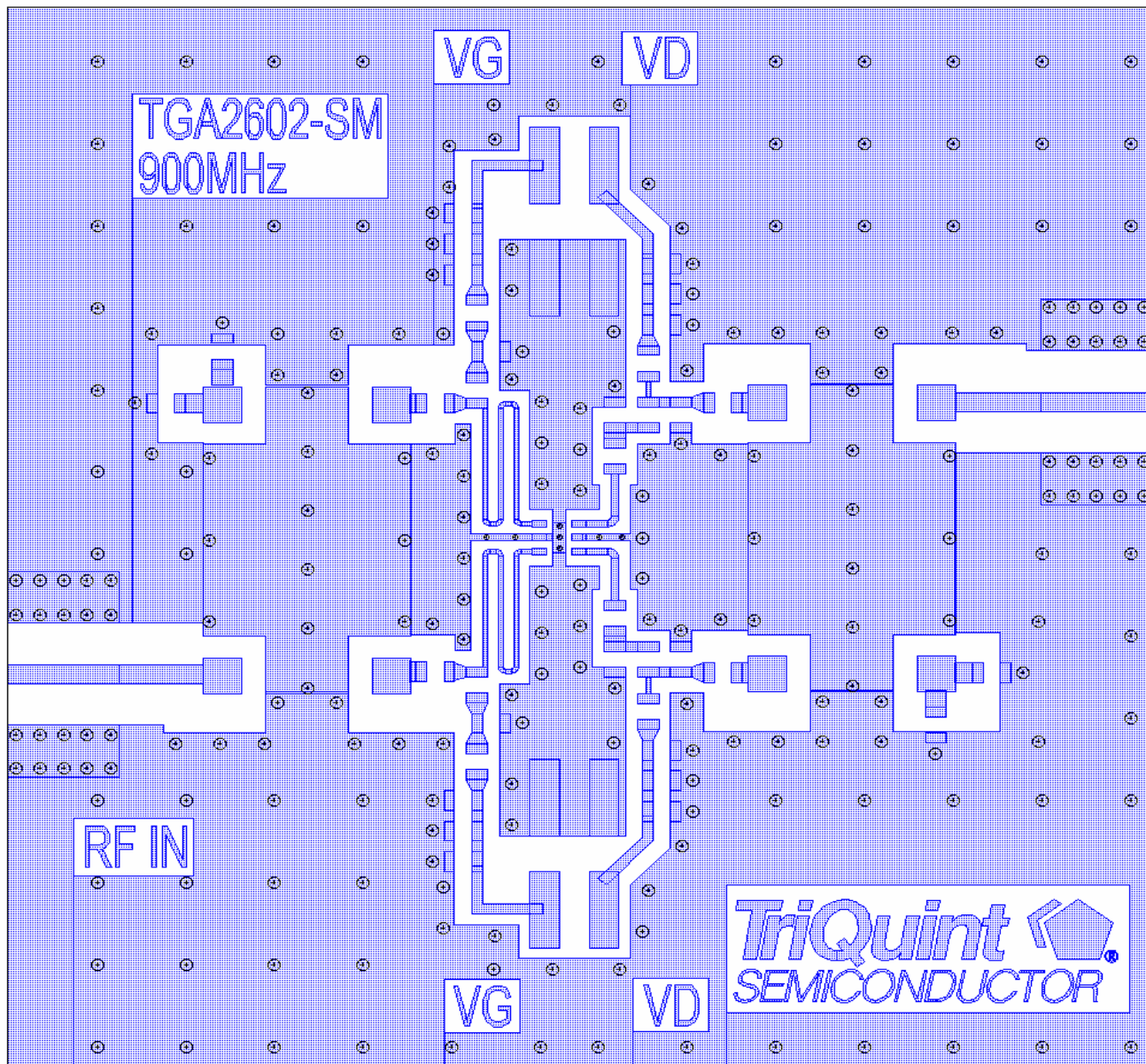

1950MHz Balanced Amplifier Layout

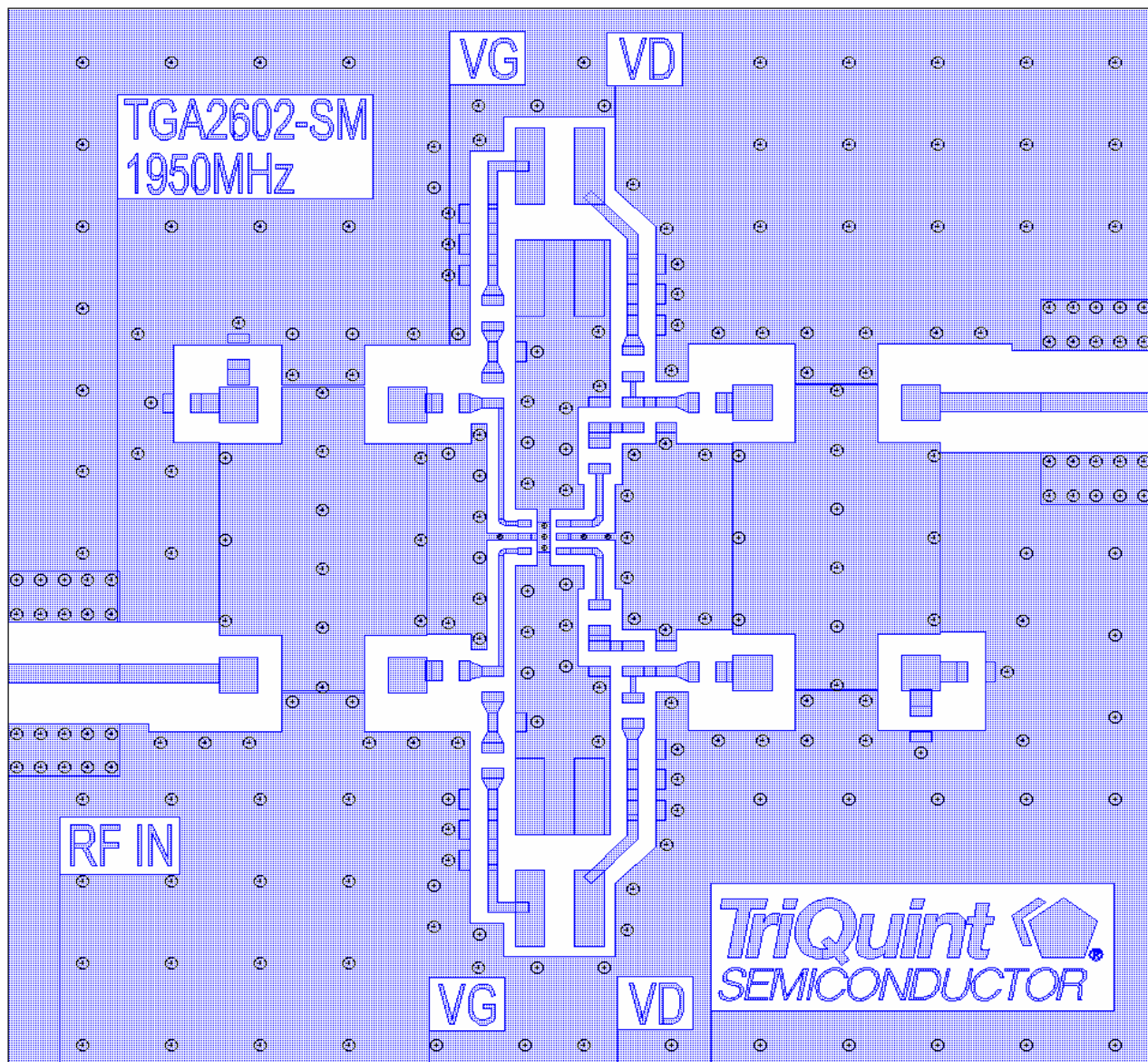

Recommended Surface Mount Package Assembly

Proper ESD precautions must be followed while handling packages.

Clean the board with acetone. Rinse with alcohol. Allow the circuit to fully dry.

TriQuint recommends using a conductive solder paste for attachment. Follow solder paste and reflow oven vendors' recommendations when developing a solder reflow profile. Typical solder reflow profiles are listed in the table below.

Hand soldering is not recommended. Solder paste can be applied using a stencil printer or dot placement. The volume of solder paste depends on PCB and component layout and should be well controlled to ensure consistent mechanical and electrical performance. *This package has little tendency to self-align during reflow.*

Clean the assembly with alcohol.

Typical Solder Reflow Profiles

Reflow Profile	SnPb	Pb Free
Ramp-up Rate	3 °C/sec	3 °C/sec
Activation Time and Temperature	60 – 120 sec @ 140 – 160 °C	60 – 180 sec @ 150 – 200 °C
Time above Melting Point	60 – 150 sec	60 – 150 sec
Max Peak Temperature	240 °C	260 °C
Time within 5 °C of Peak Temperature	10 – 20 sec	10 – 20 sec
Ramp-down Rate	4 – 6 °C/sec	4 – 6 °C/sec

Ordering Information

Part	Package Style
TGA2602-SM	2x2 6 Lead QFN

GaAs MMIC devices are susceptible to damage from Electrostatic Discharge. Proper precautions should be observed during handling, assembly and test.